

MINDEO

CR40 Bluetooth Ring Scanner User Manual



Version: CR40_UM_EN_V1.1.4

Notice

Before operating scanner, please make sure you carefully read the following information to ensure that your scanner is able to perform at the level for which it is designed.

1. All software, including firmware, furnished to the user is on a licensed basis.
2. The right is reserved to make changes to any software or product to improve reliability, function, or design.
3. The contents of this manual are subject to change without notice.
4. The manufacturer assumes no responsibility for any loss or claims by third parties which may arise from the use of this manual.
5. Do not throw or drop the scanner or otherwise subject it to strong impact, which can damage the scanner, interrupt program execution, corrupt memory contents, or otherwise interfere with proper operation.
6. A standard packing includes a scanner, a USB cable. Accessory includes a Bluetooth USB adapter which supports reliable wireless data transmission and an AC/DC adaptor for battery charge.
7. Please charge the battery before the first time of use.

Contents

Notice	i
Contents	ii
1 Specifications.....	1
1-1 Technical specifications.....	1
1-2 Default settings for each barcode	4
1-3 Dimensions.....	5
1-4 Parts of the scanner.....	5
2 Introduction to installation.....	6
2-1 Installing a USB HID keyboard wired scanner	6
2-2 Installing a USB virtual COM wired scanner	6
3 Operations of the scanner	7
3-1 Power on/off scanner.....	7
3-2 Charge scanner	7
3-3 Scan	7
3-3-1 Scan barcode.....	7
3-3-2 Scan Mode.....	7
3-4 Data Transfer.....	8
3-4-1 Bluetooth.....	8
3-4-2 USB HID Keyboard	10
3-4-3 USB Virtual COM	10
3-4-4 Standard Batch	10
3-4-5 Communication Setting.....	11
3-5 Indication	12
4 Barcode programming instructions.....	13
4-1 Example: Single-parameter setting by scanning 1D barcode	13
4-2 Common settings of the scanner	14
4-3 Scanning mode and some global settings	17
4-4 Beeper and vibration.....	21
4-5 Decode illumination and decode aiming pattern	22
4-6 DPM, Multiple symbols, Structured append, etc. read setting	23
4-7 UPC-A	26
4-8 UPC-E	28
4-9 UPC-E1	30
4-10 EAN-13 (ISBN/ISSN).....	32
4-11 EAN-8	34
4-12 Code 39 (Code 32, Trioptic Code 39).....	36
4-13 Interleaved 2 of 5.....	39

4-14 Industrial 2 of 5 (Discrete 2 of 5).....	41
4-15 Matrix 2 of 5.....	42
4-16 Codabar.....	43
4-17 Code 128.....	45
4-18 UCC/EAN 128.....	47
4-19 ISBT 128.....	49
4-20 Code 93.....	50
4-21 Code 11.....	51
4-22 MSI/Plessey.....	53
4-23 UK/Plessey.....	55
4-24 China Post.....	56
4-25 China Finance.....	57
4-26 GS1 DataBar (GS1 DataBar Truncated).....	59
4-27 GS1 DataBar Limited.....	60
4-28 GS1 DataBar Expanded.....	61
4-29 PDF417.....	62
4-30 MicroPDF417.....	63
4-31 QR Code.....	64
4-32 Micro QR Code.....	65
4-33 Data Matrix.....	66
4-34 Aztec Code.....	67
4-35 G1-G6 & C1-C3 & FN1 substitution string setting.....	68
4-36 G1-G4 string position & Code ID position.....	72
4-37 String transmission.....	73
5 Barcode representing non-printable character.....	76
6 ASCII Table.....	77
7 Test Chart.....	78
8 Return default parameters & firmware version.....	81
9 Configuration alphanumeric entry barcode.....	82

1 Specifications

1-1 Technical specifications

Item	1D	2D
Working range	30m(line of sight)	
Radio link	2.4GHz, Bluetooth 4.0, Class 1.5	
Interface	Bluetooth: HID keyboard, SPP, GATT Micro USB: USB HID keyboard, USB virtual COM	
Data storage	8KB for out of range batch: 500 barcodes(each barcode is of 15 bytes)	6KB for out of range batch: 375 barcodes(each barcode is of 15 bytes)
	52KB for data batch mode: 3250 barcodes(each barcode is of 15 bytes)	
Keyboard layout	USA、Turkish F/Q、French、Italian、Spanish、Slovak、Denmark、Japanese、German	
Dimensions	Length × Width × Depth:52.6mm×36mm×47mm	
Weight	40g	
Case material	ABS+PC	
Indicator	Beeper、LED、Vibrator	
Operating mode	Wearable	
Programming method	Manual(reading special barcode)	
Firmware upgrade	Online via USB interface	
Input Voltage	4.75V – 5.25V	
Standby current	1.5mA	6mA
Working current	42mA (Bluetooth On)	47mA (Bluetooth On)
Scanning current	110mA (Bluetooth On)	450mA (Bluetooth On)
Standby time	7 days	2 days
Working time	6hours(based on 1 scan/5 seconds)	5hours(based on 1 scan/5 seconds)
Charge current	400mA	
Battery	380 mAh Lithium-ion battery	
Charging time	approximately 1 hours	
Light source	650nm visible laser diode	white light
Image size	/	1280×800 pixels
Scanning angle	/	Horizontal : 42° , vertical : 26.5°

Item	1D	2D		
Scanning angle	±50° , ±65° , ±35° (Skew、 Pitch、 Roll)	±70° , ±72° , 360° (Skew、 Pitch、 Roll)		
Scanning rate	100±10 times/second	/		
Barcode contrast	minimum 20%			
Decode capability	UPC-A , UPC-E , EAN-13 , EAN-8 , ISBN/ISSN , Code 39 , Code 39 full ASCII , Code 32 , Trioptic Code 39 , Interleaved 2 of 5 , Industrial 2 of 5 , Matrix 2 of 5 , Codabar(NW7) , Code 128 , Code 93 , Code 11(USD-8) , MSI/Plessey , UK/Plessey , UCC/EAN 128 , China Post , China Finance , GS1 DataBar(formerly RSS)variants	1D: UPC-A , UPC-E , EAN-13 , EAN-8 , ISBN/ISSN , Code 39 , Code 39 full ASCII , Code 32 , Trioptic Code 39 , Interleaved 2 of 5 , Industrial 2 of 5 , Matrix 2 of 5 , Codabar(NW7) , Code 128 , Code 93 , Code 11(USD-8) , MSI/Plessey , UK/Plessey , UCC/EAN 128 , China Post , China Finance , GS1 DataBar(formerly RSS)variants 2D: PDF417 , MicroPDF417 , QR code , DataMatrix , Aztec Code		
Scan engine	uE966	ME5800		
Minimum resolution	4mil	HD: 1D (Code 39): 3 mil, 2D (QR): 5 mil SR: 1D (Code 39): 4 mil, 2D (PDF417): 6.7 mil		
Decoding depth	Code type	Code type	High Density Series(HD)	Standard Range Series (SR)
	4mil (9B): 50-90mm	3mil Code 39 (3B)	60-90mm	/
	5mil (12B): 50-115mm	4mil Code 128 (9B)	45-135mm	85-145mm
	10mil (3B): 20-260mm	10mil Code 39 (3B)	20-260mm	30-310mm
	15mil (3B): 30-380mm	13mil UPC (6B)	17-275mm	25-330mm
	20mil (3B): 45-490mm	20mil Code 39 (1B)	38-410mm	30-485mm
	30mi l(2B): 40-700mm	5mil QR (40 B)	55-95mm	/
	55mil (2B): 80-850mm	6.7mil PDF417 (20 B)	35-175mm	75-190mm
	/	10mil QR (20B)	20-195mm	48-190mm
	/	10mil DM (20B)	25-185mm	50-185mm
/	20mil QR (20B)	20-320mm	20-390mm	
Temperature	working: -15°C to 50°C (5°F to 122°F) storage: -20°C to 60°C (-4°F to 140°F)			
Humidity	5% to 95%(non-condensing)			

Item	1D	2D
Safety	Laser safety: EN60825-1 , Class 1 EMC : EN55022 , EN55024 Electrical safety: EN60950-1 Illumination: 0~100,000LUX Protection class: IP50 Drop resistance: Multiple 1m(3.2ft)drops to concrete Environmental: RoHS compliant	

1-2 Default settings for each barcode

Code type	Read enable	Check digit verification	Check digit transmission	Min.code length	Proprietary code ID	AIM code ID
UPC-A	√	√	√	(12) ²	A	JEm
UPC-E	√	√	√	(8) ²	D	JEm
UPC-E1	-	√	√	(8) ²	D	JX0
EAN-13	√	√	√	(13) ²	A	JEm
EAN-8	√	√	√	(8) ²	C	JE4
ISBN/ISSN ¹ (Bookland EAN)	√	√	√	(13) ²	B	JEm
Code 39	√	-	-	1	M	JAm
Interleaved 2 of 5	√	-	-	6	I	JIm
Industrial 2 of 5	-	-	-	4	H	JS0
Matrix 2 of 5	√	-	-	6	X	JX0
Codabar	√	-	-	4	N	JFm
Cade 128	√	√	-	1	K	JCm
UCC/EAN 128	√	√	-	1	K	JCm
ISBT 128	√	√	-	1	K	JCm
Code 93	√	√	-	1	L	JGm
Code 11	-	√	-	4	V	JH3
MSI/Plessey	-	-	-	4	O	JMm
UK/Plessey	√	√	-	1	U	JMm
China Post	√	-	-	(11) ²	T	JIm
China Finance	√	-	-	(10) ²	Y	-
GS1 DataBar	√	-	-	(16) ²	R	Jem
GS1 DataBar Truncated ³	√	-	-	(16) ²	R	Jem
GS1 DataBar Limited	√	-	-	(16) ²	R	Jem
GS1 DataBar Expanded	√	-	-	1	R	Jem
GS1 Composite	-	-	-	-	y	Jem
PDF417	√	-	-	-	p	JLm
MicroPDF417	-	-	-	-	p	JLm
QR	√	-	-	-	q	JQm
Micro QR	-	-	-	-	q	JQm
DataMatrix	√	-	-	-	d	Jdm
Code Aztec	-	-	-	-	a	Jzm

Note: ¹The settings for ISBN/ISSN and EAN-13 must be the same.

² Fixed-length barcodes.

³The settings for GS1 DataBar Truncated and GS1 DataBar must be the same.

1-3 Dimensions

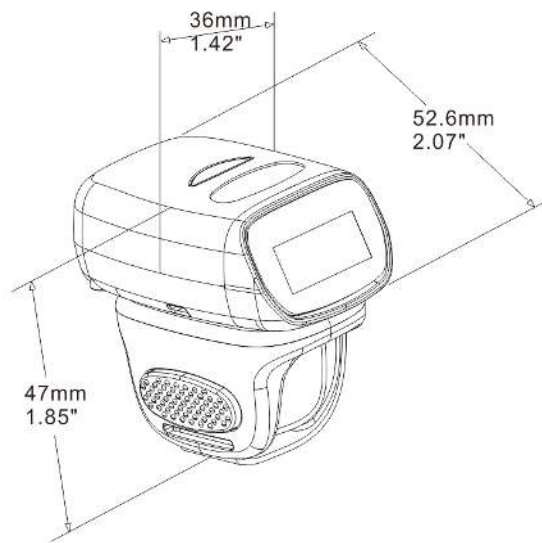

Figure 1-1 Dimensions of the scanner

1-4 Parts of the scanner

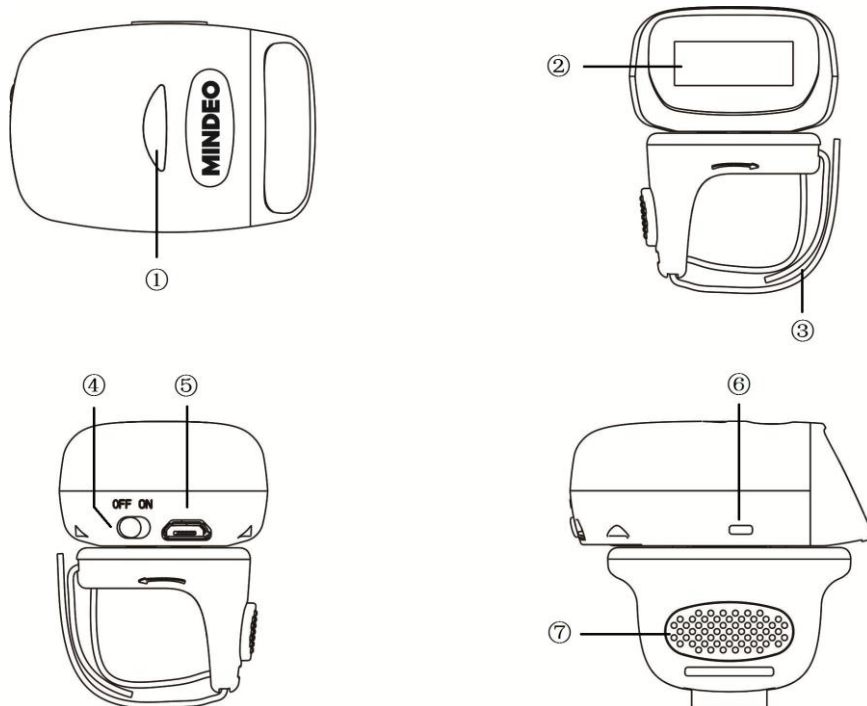

Figure 1-2 Parts of the scanner

- ① LED
- ② Scan window
- ③ Ring strap
- ④ Power switch
- ⑤ Micro USB port / Battery charging port
- ⑥ Beeper
- ⑦ Trigger

2 Introduction to installation

2-1 Installing a USB HID keyboard wired scanner

Note: The default interface of the scanner is Bluetooth. Please change the Data Transfer to USB HID Keyboard Mode (See [3-4-2 USB HID Keyboard](#)).

1. Refer to Figure 2-1, plug one end of the USB cable to the scanner. Plug the other end into the USB port of the computer.
2. For example: Using Microsoft Windows operation system, the system gives message on “new hardware found – USB HID input device found”, then driver will be installed on request.
3. After successfully installing the new hardware, message will be given: “hardware installed successfully and ready to use”.
4. If any problem is encountered during the installation process, unplug the USB cable from the computer and repeat step 1-2.

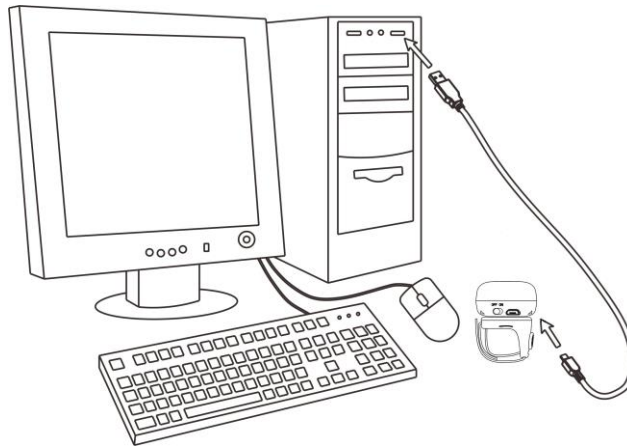

Figure 2-1 Diagram of connecting the scanner to PC

2-2 Installing a USB virtual COM wired scanner

Note: The default interface of the scanner is BT HID Keyboard. Please change the Data Transfer to USB Virtual COM Mode (See [3-4-3 USB Virtual COM](#)).

1. Refer to Figure 2-1, plug one end of the USB cable to the scanner. Plug the other end into the USB port of the computer.
2. For example: Using Microsoft Windows operation system, the system gives message on “new hardware found – USB Virtual COM found” for USB virtual COM, then driver will be installed on request.
3. After successfully installing the new hardware, message will be given: “hardware installed successfully and ready to use”.
4. If any problem is encountered during the installation process, unplug the USB cable from the computer and repeat step 1 to step 2.

3 Operations of the scanner

Note:

1. Please establish a Bluetooth in the range of the network before the first time of scanning barcodes.
2. The scanner can perform a barcode scan operation even though no Bluetooth network is available. However, the scanner may react in a way that differs from what is described here if no Bluetooth is working.

3-1 Power on/off scanner

Power on scanner: Turn the Power switch on.

Power off scanner: Turn the Power switch off.

3-2 Charge scanner

1. Please charge the scanner before the first time of use. There are two methods of charging battery as demonstrated in Figure 3-1. The charging indicator (red LED) on the scanner is turned on when the charging is in process. When the charging process completes, the red LED is turned off.
2. Charging time: 1.5 hours for fully charged.

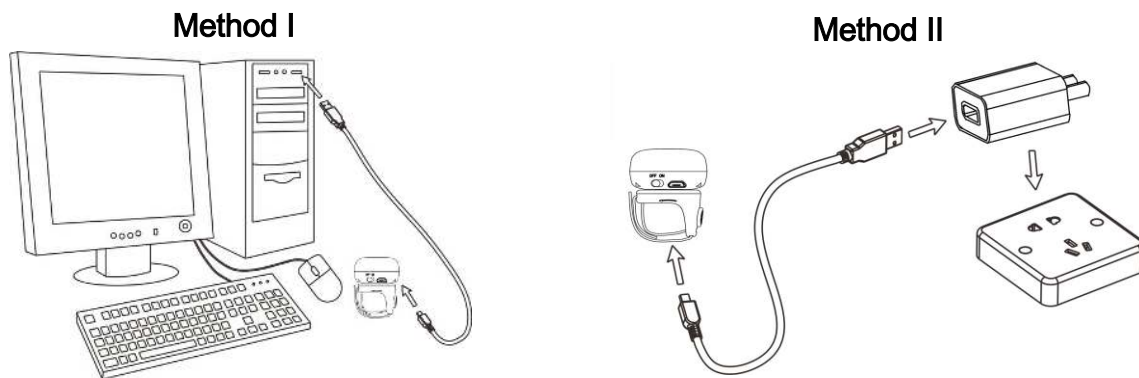

Figure 3-1 Diagram of charging battery

3-3 Scan

3-3-1 Scan barcode

Steps:

Step 1: The scanner is powered on.

Step 2: Wear the scanner on one finger, move the scanner close to the barcode and press the trigger button. LED lights green and flash one time when the scan is successful.

3-3-2 Scan Mode

Good-read off - The trigger button must be pressed once to activate scanning. The light source of scanner stops scanning when there is a successful reading or no code is decoded after the Stand-by duration elapsed.

Momentary - The trigger button acts as a switch. Press button to activate scanning and release button to stop scanning. The light source of scanner stops scanning when there is a successful reading or no code is decoded after the Stand-by duration elapsed.

Continuous - The scanner always keeps scanning, and it does not matter when the trigger button is released or duration is elapsed.

Note: 2D do not support “Continuous” mode.

3-4 Data Transfer

3-4-1 Bluetooth

The scanner can be configured to send data to a PC/Notebook/PDA/other instrument which has an integrated Bluetooth module or is connected with an external Bluetooth USB adapter. A diagram of Bluetooth functionalities and a table of various Bluetooth profiles are shown below, respectively:

Table 3-1 Various Bluetooth profiles

HID Keyboard	The scanner connects to the PC/host via Bluetooth and behaves like a keyboard. The scanner accepts incoming connection requested from a remote device and is the slave.
SPP	The scanner connects to the PC/host via Bluetooth and behaves like there is a serial connection.
GATT	BLE slave, a Bluetooth 4.0 device will pair with the scanner, so that the scanner can transfer data with low power.
BA2110	The scanner connects to the PC via BA2110 and behaves like a keyboard.

Note: Bluetooth-enabled smart phones and PDAs can host the scanner in general. However, ordinary mobile phones with Bluetooth function cannot be a host of the scanner because in most cases neither HID nor SPP profile is supported by them.

Inter-barcode delay – This delay is inserted after each barcode transmitted. Some Bluetooth communication needs large delay to avoid data missing. This default delay is set to 0 milliseconds.

Inter-char delay – Inter-character delay is abbreviated to Inter-char delay. This delay is inserted after each data character transmitted when configure Bluetooth to HID keyboard profile. Some Bluetooth communication needs large delay to avoid data missing. This default delay is set to 0 milliseconds.

Auto reconnection – When scanner’s Bluetooth is power on, it will try to establish the wireless connection with the host which it last connected. The default setting is enabled.

Out-of-range batch – The wearable unit starts storing barcode when it loses its connection to a remote device (for example, when a user move the wearable unit walks out of range). Data transmission is triggered by reestablishing the connection with the cradle (for example, when a user move the wearable unit walks back into range). The default setting is disabled.

3-4-1-1 Configure Bluetooth HID Keyboard profile communication

Step 1: Scan the barcode below to setting bluetooth profile for data transfer.



Data Transfer - Bluetooth

Step 2: Scan the **Bluetooth-HID** barcode below.



Bluetooth-HID

Step 3: When a device that supports Bluetooth 4.0 is connected to the scanner, the LED on the top of the scanner will remain blue and the device will receive incoming data from the scanner.

3-4-1-2 Configure Bluetooth SPP profile communication

Step 1: Scan the barcode below to setting bluetooth profile for data transfer.



Data Transfer - Bluetooth

Step 2: Scan the **Bluetooth-SPP** barcode below.



Bluetooth-SPP

Step 3: When a device that supports Bluetooth 4.0 is connected to the scanner, the LED on the top of the scanner will remain blue and the device will receive incoming data from the scanner.

3-4-1-3 Configure Bluetooth GATT profile communication

Step 1: Scan the barcode below to setting bluetooth profile for data transfer.



Data Transfer - Bluetooth

Step 2: Scan the **Bluetooth-GATT** barcode below.



Bluetooth - GATT

Step 3: When a device that supports Bluetooth 4.0 is connected to the scanner, the LED on the top of the scanner will remain blue and the device will receive incoming data from the scanner.

3-4-1-4 Configure Bluetooth USB adapter BA2110

Note1: BA2110 is provided by the manufacturer to support reliable wireless data transmission, and it is advised in applications whereas unacknowledged communication is unacceptable.

Step 1: Scan the barcode below to setting bluetooth profile for data transfer.



Data Transfer - Bluetooth

Step 2: Scan the **Bluetooth-BA2110** barcode below.



Bluetooth - BA2110

Step 3: Plug a BA2110 into the USB port of the computer

Step 4: Scan the barcode on the back of BA2110.

Step 5: When the scanner pairs with BA2110, the LED on the top of the scanner will remain blue and the device will receive incoming data from the scanner.

3-4-2 USB HID Keyboard

When the scanner is USB connected to a PC in USB HID Keyboard Mode, it will be identified as a USB HID keyboard and behaves as a USB wired scanner.

Keyboard layout – supports different national keyboard layouts. The default setting is USA.

Inter-char delay – Inter-character delay is abbreviated to Inter-char delay. This delay is inserted after each data character transmitted when configure Bluetooth to HID keyboard profile. Some Bluetooth communication needs large delay to avoid data missing. This default delay is set to 0 milliseconds.

3-4-2-1 Configure USB HID Keyboard communication

Step 1: Scan the barcode below to setting USB HID Keyboard for data transfer.



Data Transfer - USB HID Keyboard

Step 2: Installation (See [2-1 Installing a USB HID keyboard wired scanner](#)).

3-4-3 USB Virtual COM

When the scanner is USB connected to a PC in USB Virtual COM Mode, it will be identified as a USB Virtual COM and acts as a RS-232 wired scanner.

3-4-3-1 Configure USB Virtual COM communication

Step 1: Scan the barcode below to setting USB Virtual COM for data transfer.



Data Transfer - USB Virtual COM

Step 2: Installation (See [2-2 Installing a USB virtual COM wired scanner](#)).

3-4-4 Standard Batch

The scanner starts storing barcode in Standard Batch Mode. The collected barcode can then be sent to a host via Bluetooth/USB. Three options are listed below.

Send batch data - Data transmission is triggered by this menu command. Before undertaking this operation, make sure a communication link (Bluetooth network or USB cable) is working.

Interfaces - There are three types of communication interfaces Bluetooth, USB HID keyboard and USB virtual COM. A Bluetooth link is needed in the first case (See [3-4-1 Bluetooth](#)).

Auto Clear – By enable, the scanner will clear the stored barcode after finishing sending. The default

setting is disabled.

Inter-barcode delay – This delay is inserted after each barcode transmitted. Some Bluetooth communication needs large delay to avoid data missing. This default delay is set to 0 milliseconds.

3-4-4-1 Configure Standard Batch communication

Note1: The following is configure Standard Batch communication and send data in Bluetooth-SPP.

Step 1: Scan the barcode below to setting Standard Batch for data transfer.



%0211D03%

Data Transfer - Standard Batch

Step 2: Scan the barcode below to setting bluetooth profile for Standard Batch.



%0251D00%

Standard Batch - Bluetooth

Step 3: Scan the **Bluetooth-SPP** barcode below.



%0231D01%

Bluetooth-SPP

Step 4: The scanner starts storing barcode.

Step 5: Scan the **Send batch data** barcode below ,the collected barcode can then be sent to a host via Bluetooth-SPP.



%%%SBD

Standard Batch - Send batch data

3-4-5 Communication Setting

See [4-2 Common settings of the scanner.](#)

3-5 Indication

The scanner contains LEDs on the top of the unit that indicate linking status, decoding state, and battery condition. The following table lists the LED indicators, beeps, and vibrations for the scanner.

Table 3-2 Indication

	Cause	LED Indication	Beeper indication	Vibrate indication
Bluetooth	No Bluetooth connection	Blue flash	None	None
	Successful Bluetooth connection	Blue on	2 short beeps	Short vibration
	Disconnect	None	1 long beep	Long vibration
Battery	The charging is in process	Red on	None	None
	The charging process completes	Red off	None	None
Bar code reading	Bar code successful read	Green flash	1 short beep	Short vibration
	Bar code unsuccessful read	Green flash	2 long beep	Short vibration
	Bar code successful read and data transfer error	Green flash	2 long beep	Long vibration
Setting	Wait for the setting	Blue and green flash	None	None
	Successful setting	None	2 short beeps	Short vibration
	Error	None	1 long beep	Long vibration
Other	Power on	None	Start up sound	None

4 Barcode programming instructions

4-1 Example: Single-parameter setting by scanning 1D barcode

Important notes:

1. During the process of programming, LED is lighting to indicate the programming correctness. LED will go off if any incorrect programming operation performed.
2. After each successful programming, LED will go off and the scanner will beep twice.
3. Throughout the programming barcode menus, the factory default settings are indicated with asterisks (*).

Two programming modes have been provided as bellows:

① Single-scan setting

Scan the appropriate **Single-scan setting** according to the user's demand.

Example: To set **Flow control** to be XON/XOFF.

Steps: Scan the following barcode.



② Multiple-scan setting

Step 1: Scan the **Option barcode** barcode according to the user's demand.

Step 2: To the right of the option barcode, the necessary alphanumeric inputs are listed. Scan two alphanumeric entries from **0** to **9** or **A** to **F**, refer to *11 Configuration alphanumeric entry barcode*.

Step 3: Repeat Step 2, if more user parameters input are required.







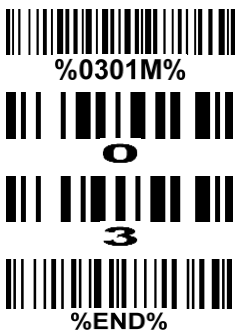

Step 4: Scan the **%END%** barcode, listed on the lower left hand corner of each parameter setting part.





















Example: To set **Flow control** to be XON/XOFF.



Steps: Scan the following barcodes in order.

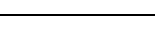
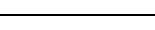
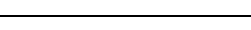

4-2 Common settings of the scanner

Multiple-scan setting			Single-scan setting
Option barcode	Option	Alpha. Entry	
Data Transfer  %0211M%	Bluetooth	00*	 %0211D00% *
	USB HID Keyboard	01	 %0211D01%
	USB Virtual COM	02	 %0211D02%
	Standard Batch	03	 %0211D03%
Bluetooth  %0231M%	HID	00*	 %0231D00% *
	SPP	01	 %0231D01%
	GATT	02	 %0231D02%
	BA2110	03	 %0231D03%
Out-of-range batch in Bluetooth  %0237M%	Disable	00*	 %0237D00% *
	Enable	01	 %0237D01%
Auto reconnection in Bluetooth  %0240M%	Disable	00	 %0240D00%
	Enable	01*	 %0240D01% *
Inter-char delay in HID Bluetooth  %0250M%	00-99 (00: no)	00*	 %0250D00% *
		00-99	
Keyboard layout in HID Bluetooth or USB HID Keyboard  %0241M%	USA	00*	 %0241D00% *
	Turkish F	01	 %0241D01%
	Turkish Q	02	 %0241D02%
	French	03	 %0241D03%
	Italian	04	 %0241D04%

Multiple-scan setting			Single-scan setting
Option barcode	Option	Alpha. Entry	
	Spanish	05	 %0241D05%
	Slovak	06	 %0241D06%
	Denmark	07	 %0241D07%
	Japanese	08	 %0241D08%
	German	09	 %0241D09%
Inter-char delay(ms) in USB HID Keyboard  %0242M%	00-99 (00: no)	00*	 %0242D00%
		00-99	
Inter-barcode delay (100ms) in Standard Batch  %0250M%	00-99 (00: no)	00*	 %0250D00% *
		00-99	
Data Transfer in Standard Batch  %0251M%	Bluetooth	00	 %0251D00%
	USB HID Keyboard	01	 %0251D01%
	USB Virtual COM	02	 %0251D02%
Auto Clear in Standard Batch  %0252M%	Disable	00*	 %0252D00% *
	Enable	01	 %0252D01%
Send batch data in Standard Batch	None	None	 %%SBD
Clear batch data in Standard Batch	None	None	 %%CBD
Disconnect Bluetooth	None	None	 %%DISC
Display Bluetooth name	None	None	 %%BTN
Change the name of Bluetooth	Example: MINDEO (Up to 12 characters)	None	 %BTN%MINDEO
Display Bluetooth Mac address	None	None	 %%BMAC

Multiple-scan setting			Single-scan setting
Option barcode	Option	Alpha. Entry	
Switching the virtual keyboard on Apple iOS	None	None	 %%OSK
 %END%			

4-3 Scanning mode and some global settings

Scanning mode:

Good-read off -The trigger button must be pressed once to activate scanning. The light source of scanner stops scanning when there is a successful reading or no code is decoded after the **Stand-by duration** elapsed.

Momentary -The trigger button acts as a switch. Press button to activate scanning and release button to stop scanning. The light source of scanner stops scanning when there is a successful reading or no code is decoded after the **Stand-by duration** elapsed.

Continue -The trigger button acts as a toggle switch. Press button to activate or stop scanning.

Notice: 2D model dot not support Continue mode.

Same barcode delay time: If a barcode has been scanned and output once successfully, the laser beam must be off or moved away from the barcode beyond delay time to active scanning the same barcode. When this feature is set to be "0xFF", then the delay time is indefinite.

Double confirm: If it is enabled, the scanner will require a several times of same-decoded-data to confirm a valid reading.

Global Max./Min. code length for 1D symbol: These two lengths are defined as the valid range of decoded 1D barcode data length. Make sure that the minimum length setting is no greater than the maximum length setting, or otherwise the labels of the symbol will not be readable. In particular, the same value can be set for both minimum and maximum reading length to force the fixed length barcode decoded.

Note1: Please set the max./min. length for individual barcode in later sections, if special demand is requested.

Note2: The number of check digits is included in max./Min. code length.

Note3: These two settings have no effect on the symbols with fixed-length, e.g. UPC-A, UPC-E, EAN-13, EAN-8 and China Post.

Global G1-G6 string selection: The scanner offer one or two string group for ALL symbols. By setting one or two digits to indicate which string group you want to apply. You may refer to [7-33 G1-G6 & C1-C3 & FN1 substitution string setting](#) and [7-34 G1-G4 string position & Code ID position](#).

Example: Group 1 → set 01 or 10. Group 2 and 4 → set 24 or 42.

All valid settings include 00, 01, 02, 03, 04, 05, 06, 10, 11, 12, 13, 14, 15, 16, 20, 21, 22, 23, 24, 25, 26, 30, 31, 32, 33, 34, 35, 36, 40, 41, 42, 43, 44, 45, 46, 50, 51, 52, 53, 54, 55, 56, 60, 61, 62, 63, 64, 65 and 66.

Element amendment: If it is enabled, the scanner can read the barcode comprised with bars and spaces in different scale.

Character output restraint:

Printable character only- If this option is selected, the scanner will output the printable characters only, i.e. in ASCII from 20H to 7EH.

Alphanumeric character only- If this option is selected, the scanner will output the alphanumeric characters only, i.e. "A"- "Z", "a"- "z", "0"- "9".



















Decoder optimization: If it is enabled, the scanner will optimize the decoder with error correction. This













function is not effective for all types of barcodes.

Character encoding system: A character encoding system consists of a code that pairs each character from a given repertoire. Common examples include Morse code, the Baudot code, the ASCII and Unicode. If the data received does not display with the proper characters, it may be because the barcode being scanned was created using a character encoding system that is different from the one the host program is expecting. Try alternate options to find the proper one.

Sleep mode: the scanner will go to sleep when no code is successful decoded after the Sleep mode delay elapsed.

Sleep mode delay: When no code is successful decoded beyond this time, the scanner will go to sleep.







Multiple-scan setting			Single-scan setting
Option barcode	Option	Alpha. entry	
Scanning mode  %0401M%	Good-read off	00	 %0401D00%
	Momentary	01*	 %0401D01% *
	Continue	02	 %0401D02%
Standby duration  %0402M%	01-99 (second)	01-99	
		04*	 %0402D04% *
Same barcode delay time  %0403M%	00-FF ₁₆ (50ms)	00-FF ₁₆	
		08*	 %0403H08% *
Double confirm  %0404M%	00-09 (00: no)	00-09	
		00*	 %0404D00% *
Global Max. code length for 1D symbol  %0405M%	04-99	04-99	
		99*	 %0405D99% *
Global Min. code length for 1D symbol  %0406M%	01-99	01-99	
		04*	 %0406D04% *
Global G1-G6 string selection  %0407M%	00-66	00-66	
		00*	 %0407D00% *
Element amendment  %0408M%	Disable	00	 %0408D00%
	Enable	01*	 %0408D01% *
Character output restraint  %0409M%	None	00*	 %0409D00% *
	Printable character only	01	 %0409D01%
	Alphanumeric character only	02	 %0409D02%
Decoder optimization	Disable	00	 %0410D00%

Multiple-scan setting			Single-scan setting
Option barcode	Option	Alpha. entry	
 %0410M%	Enable	01*	 %0410D01%*
Character encoding system  %0413M%	ASCII	00*	 %0413D00%*
	UTF-8	01	 %0413D01%
	Windows-1251	02	 %0413D02%
Sleep mode delay  %0226M%	10s	00	 %0226D00%
	30s	01*	 %0226D01%*
	60s	02	 %0226D02%
	180s	03	 %0226D03%
	Disable	04	 %0226D04%
 %END%			

4-4 Beeper and vibration

Frequency of vibration: This parameter can be adjusted for different level of the frequency of vibration.











Volume of beeper: This parameter can be adjusted for different level of the volume of the beeper.

Multiple-scan setting			Single-scan setting
Option barcode	Option	Alpha. Entry	
Frequency of vibration  %0222M%	Low	00	 %0222D00%
	Middle	01	 %0222D01%
	High	02*	 %0222D02% *
	Disable	03	 %0222D03%
Volume of beeper  %0223M%	Low	00	 %0223D00%
	Middle	01	 %0223D01%
	High	02*	 %0223D02% *
	Disable	03	 %0223D03%
 %END%			

4-5 Decode illumination and decode aiming pattern

Decode illumination mode: Enable illumination causes the scanner to turn on the illumination to aid decoding. Disable illumination to turn off illumination for the scanner during decoding. Better quality images could be obtained with illumination support. The effectiveness of the illumination decreases as the distance to the target increases.

Decode aiming pattern: When this option is enabled, the scanner will project the aiming pattern during the code capture.

Multiple-scan setting			Single-scan setting
Option barcode	Option	Alpha. Entry	
Decode illumination  %9001M%	Always Off	00	 %9001D00%
	Always On	01	 %9001D01%
	Flashing	02*	 %9001D02% *
	Always-On when reading	03	 %9001D03%
Decode aiming pattern  %9002M%	Always Off	00	 %9002D00%
	Always On	01	 %9002D01%
	On before reading	02	 %9002D02%
	On when reading	03*	 %9002D03% *
 %END%			

4-6 DPM, Multiple symbols, Structured append, etc. read setting

2D symbols read: A global setting of 2D symbols readability.

DPM format read: By setting Enable, the scanner can read 2D symbols in DPM (Direct Park Marking) format. Some barcodes in DPM format are shown below.

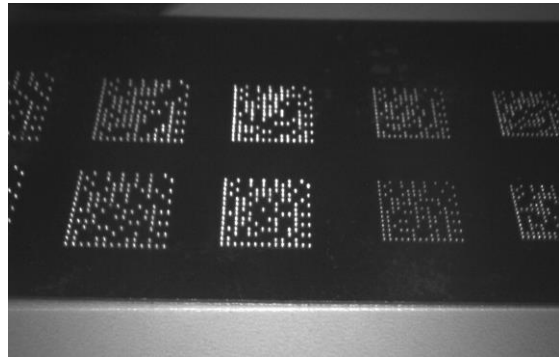





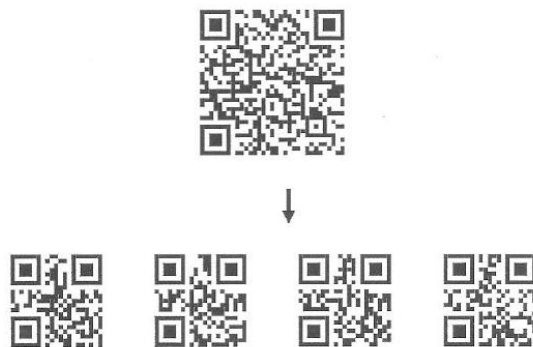









Multiple symbols & structured append symbols read:

- 1) By setting Enable, the scanner allows to read multiple symbols with a single pull of the scanner's trigger. If the user pulls and holds the trigger, aiming the scanner at a series of symbols, it reads unique symbols once, beeping for each success read. The scanner attempts to find and decode new symbols as long as the trigger is pulled.
- 2) By setting Enable, the scanner will output data only when all Structured Append symbols have been decoded. The lower part of below figure shows an example of four Structured Append symbols, with the same data as that in the upper symbol.
- 3) By setting Disable, the scanner will only read the symbol closest to the aiming beam.



Single symbol (above) and Structured Append series of symbols (below) encoding
"ABCDEFGHIJKLMNOPQRSTUVWXYZ0123456789ABCDEFGHIJKLMNOPQRSTUVWXYZ"

Multiple-scan setting			Single-scan setting
Option barcode	Option	Alpha. entry	
2D symbols read  %1001M%	Follow respective 2D symbol setting	00*	 %1001D00% *
	All 2D OFF	01	 %1001D01%
	All 2D ON	02	 %1001D02%
	Only PDF417 ON	03	 %1001D03%
	Only QR code ON	04	 %1001D04%
	Only Data Matrix ON	05	 %1001D05%
	Only MaxiCode ON	06	 %1001D06%
	Only Aztec Code ON	07	 %1001D07%
DPM format read  %1002M%	Disable	00*	 %1002D00% *
	Enable	01	 %1002D01%
Decode multi-symbols in one read  %1003M%	Multi-symbols	00	 %1003D00%
	One symbol only	01*	 %1003D01% *



Note: The instruction of calibrating the aimer in vertical centering direction.

1. Scan the barcode on this page. The scanner will give three musical short beeps to indicate entering calibration mode.
2. Press the trigger of the scanner while maintaining the distance of about 15cm between the exit window of the scanner and this paper. After a few seconds, the scanner will give three short beeps to indicate a successful calibration, or a long beep to indicate a failed calibration.
3. If the calibration is failed in step 2, please repeat the steps 1-2. If it is not succeed after a multiple times of calibration, please contact your local dealer or the manufacturer for further instruction.



%initD00%

4-7 UPC-A

Read:

Format

System character	Data digits (10 digits)	Check digit
------------------	-------------------------	-------------

Check digit verification: The check digit is optional.

Check digit trans.: By setting Enable, check digit will be transmitted.

Code ID setting: Code ID is a one-or-two-character string used to represent the symbol upon a succeeding reading. If you want application to transmit Code ID, you must set Code ID transmission to be enabled. Refer to [7-35 String transmission](#).

Insertion group selection: Refer to Global insertion group selection of [7-4 Scanning mode and some global settings](#).

Supplement digits: The Supplement digits barcode is the supplemental 2 or 5 characters.























Format

System character	Data digits (10 digits)	Check digit	Supplement digits 2 or 5
------------------	-------------------------	-------------	--------------------------

Truncation/Expansion:

Truncate leading zeros- The leading "0" digits of UPC-A data characters can be truncated when the feature is enabled.

Expand to EAN-13- It extends to 13-digits with a "0" leading digit when the feature is enabled.

Multiple-scan setting			Single-scan setting
Option barcode	Option	Alpha. entry	
Read  %1101M%	Disable	00	 %1101D00%
	Enable	01*	 %1101D01% *
Check digit verification  %1102M%	Disable	00	 %1102D00%
	Enable	01*	 %1102D01% *
Check digit trans.  %1103M%	Disable	00	 %1103D00%
	Enable	01*	 %1103D01% *
Code ID setting  %1104M%	00-FF ₁₆ (ASCII)	00-FF ₁₆	
		<A>*	 %1104H41% *
Insert group selection  %1105M%	00-66	00-66	
		00*	 %1105D00%
Supplement digits  %1106M%	None	00*	 %1106D00% *
	2 digits	01	 %1106D01%
	5 digits	02	 %1106D02%
	2 or 5 digits	03	 %1106D03%
Truncation/Expansion  %1107M%	None	00*	 %1107D00% *
	Truncate leading zeros	01	 %1107D01%
	Expand to EAN-13	02	 %1107D02%



4-8 UPC-E

Read:

Format

System character "0"	Data digits (6 digits)	Check digits
----------------------	------------------------	--------------

Check digit verification: The check digit is optional and made as the sum of the numerical value of the data digits.

Check digit trans.: By setting Enable, check digit will be transmitted.

Code ID setting: Refer to

Code ID setting

 of [7-5 UPC-A](#).

Insertion group selection: Refer to

Insertion group selection

 of [7-5 UPC-A](#).

Supplement digits:

Format

System character "0"	Data digits (6 digits)	Check digit	Supplement digits 2 or 5
----------------------	------------------------	-------------	--------------------------

Truncation/Expansion:

Truncate leading zeros- Refer to

Truncation/Expansion

 of [7-5 UPC-A](#).

Expand to EAN-13- It extends to 13-digits with "0" digits when the feature is set to be enabled.

Example: Barcode "0123654",

Output: "0012360000057".

Expand to UPC-A- It extends to 12-digits when the feature is set to be enabled.

Multiple-scan setting			Single-scan setting
Option barcode	Option	Alpha. entry	
Read  %1201M%	Disable	00	 %1201D00%
	Enable	01*	 %1201D01% *
Check digit verification  %1202M%	Disable	00	 %1202D00%
	Enable	01*	 %1202D01% *
Check digit trans.  %1203M%	Disable	00	 %1203D00%
	Enable	01*	 %1203D01% *
Code ID setting  %1204M%	00-FF ₁₆ (ASCII)	00-FF ₁₆	
		<D>*	 %1204H44% *
Insert group selection  %1205M%	00-66	00-66	
		00*	 %1205D00% *
Supplement digits  %1206M%	None	00*	 %1206D00% *
	2 digits	01	 %1206D01%
	5 digits	02	 %1206D02%
	2 or 5 digits	03	 %1206D03%
Truncation/Expansion  %1207M%	None	00*	 %1207D00% *
	Truncate leading zeros	01	 %1207D01%
	Expand to EAN-13	02	 %1207D02%
	Expand to UPC-A	03	 %1207D03%
 %END%			

4-9 UPC-E1

Read:

Format

System character "1"	Data digits (6 digits)	Check digits
----------------------	------------------------	--------------

Check digit verification: The check digit is optional and made as the sum of the numerical value of the data digits.

Check digit trans.: By setting Enable, check digit will be transmitted.

Code ID setting: Refer to

Code ID setting

 of [7-5 UPC-A](#).

Insertion group selection: Refer to

Insertion group selection

 of [7-5 UPC-A](#).

Supplement digits:

Format

System character "1"	Data digits (6 digits)	Check digit	Supplement digits 2 or 5
----------------------	------------------------	-------------	--------------------------

Truncation/Expansion:

Expand to EAN-13- It extends to 13-digits with "0" digits when the feature is set to be enabled.

Expand to UPC-A- It extends to 12-digits when the feature is set to be enabled.

Multiple-scan setting			Single-scan setting
Option barcode	Option	Alpha. entry	
Read  %3401M%	Disable	00	 %3401D00%
	Enable	01*	 %3401D01% *
Check digit verification  %3402M%	Disable	00	 %3402D00%
	Enable	01*	 %3402D01% *
Check digit trans.  %3403M%	Disable	00	 %3403D00%
	Enable	01*	 %3403D01% *
Code ID setting  %3404M%	00-FF ₁₆ (ASCII)	00-FF ₁₆	
		<D>*	 %3404H44% *
Insert group selection  %3405M%	00-66	00-66	
		00*	 %3405D00% *
Supplement digits  %3406M%	None	00*	 %3406D00% *
	2 digits	01	 %3406D01%
	5 digits	02	 %3406D02%
	2 or 5 digits	03	 %3406D03%
Truncation/Expansion  %3407M%	None	00*	 %3407D00% *
	Expand to EAN-13	02	 %3407D02%
	Expand to UPC-A	03	 %3407D03%



4-10 EAN-13 (ISBN/ISSN)

Read:

Format

Data digits (12 digits)	Check digit
-------------------------	-------------

Check digit verification: The check digit is optional and made as the sum of the numerical value of the data digits.

Check digit transmission: By setting Enable, check digit will be transmitted.

EAN-13 code ID setting: Refer to

Code ID setting

 of [7-5 UPC-A](#).

Insertion group selection: Refer to

Insertion group selection

 of [7-5 UPC-A](#).

Supplement digits:

Format

Data digits (12 digits)	Check digit	Supplement digits 2 or 5
-------------------------	-------------	--------------------------

ISBN/ISSN conversion: The ISBN (International Standard Book Number, or Bookland EAN) and ISSN (International Standard Serial Number) are two kinds of barcode for books and magazines. The ISBN is 10 digits with leading “978” and the ISSN is 8 digits with leading “977” of the EAN-13 symbol.

Example:

Barcode “9780194315104”, Output: “019431510X”.

Barcode “9771005180004”, Output: “10051805”.

ISBN/ISSN code ID setting: Refer to

Code ID setting

 of [7-5 UPC-A](#).

Multiple-scan setting			Single-scan setting
Option barcode	Option	Alpha. entry	
Read  %1301M%	Disable	00	 %1301D00%
	Enable	01*	 %1301D01% *
Check digit verification  %1302M%	Disable	00	 %1302D00%
	Enable	01*	 %1302D01% *
Check digit transmission  %1303M%	Disable	00	 %1303D00%
	Enable	01*	 %1303D01% *
EAN-13 code ID setting  %1304M%	00-FF ₁₆ (ASCII)	00-FF ₁₆	
		<A>*	 %1304H41% *
Insert group selection  %1305M%	00-66	00-66	
		00*	 %1305D00% *
Supplement digits  %1306M%	None	00*	 %1306D00% *
	2 digits	01	 %1306D01%
	5 digits	02	 %1306D02%
	2 or 5 digits	03	 %1306D03%
ISBN/ISSN conversion  %1307M%	Disable	00*	 %1307D00% *
	Enable	01	 %1307D01%
ISBN/ISSN code ID setting  %1309M%	00-FF ₁₆ (ASCII)	00-FF ₁₆	
		*	 %1309H42% *



4-11 EAN-8

Read:

Format

Data digits (7 digits)	Check digit
------------------------	-------------

Check digit verification: The check digit is optional and made as the sum of the numerical value of the data digits.

Check digit trans.: By setting Enable, check digit will be transmitted.

Code ID setting: Refer to

Code ID setting

 of *7-5 UPC-A*.

Insertion group selection: Refer to

Insertion group selection

 of *7-5 UPC-A*.

Supplement digits:

Format

Data digits (7 digits)	Check digit	Supplement Digits 2 or 5
------------------------	-------------	--------------------------

Truncation/Expansion: Refer to

Truncation/Expansion

 of *7-5 UPC-A*.

Multiple-scan setting			Single-scan setting
Option barcode	Option	Alpha. entry	
Read  %1401M%	Disable	00	 %1401D00%
	Enable	01*	 %1401D01% *
Check digit verification  %1402M%	Disable	00	 %1402D00%
	Enable	01*	 %1402D01% *
Check digit trans.  %1403M%	Disable	00	 %1403D00%
	Enable	01*	 %1403D01% *
Code ID setting  %1404M%	00-FF ₁₆ (ASCII)	00-FF ₁₆	
		<C>*	 %1404H42% *
Insert group selection  %1405M%	00-66	00-66	
		00*	 %1405D00% *
Supplement digits  %1406M%	None	00*	 %1406D00% *
	2 digits	01	 %1406D01%
	5 digits	02	 %1406D02%
	2 or 5 digits	03	 %1406D03%
Truncation/Expansion  %1407M%	None	00*	 %1407D00% *
	Truncate leading zero	01	 %1407D01%
	Expand to EAN-13	02	 %1407D02%



4-12 Code 39 (Code 32, Trioptic Code 39)

Read:

Format

Start character (*)	Data digits (variable)	Check digit (optional)	End character (*)
---------------------	------------------------	------------------------	-------------------

Check digit verification: The check digit is optional and made as the sum module 43 of the numerical value of the data digits.

Check digit transmission: By setting Enable, check digit will be transmitted.

Max./Min. code length: Each symbol has own max./Min. code length. If both setting of max./Min. code length are "00"s, the setting of global max./Min. code length is effective. The length is defined as to the actual barcode data length to be sent. Label with length exceeds these limits will be rejected. Make sure that the minimum length setting is no greater than the maximum length setting, or otherwise all the labels of the symbol will not be readable. In particular, you can see the same value for both minimum and maximum reading length to force the fixed length barcode decoded.

Code ID setting: Refer to

Code ID setting

 of [7-5 UPC-A](#).

Insertion group selection: Refer to

Insertion group selection

 of [7-5 UPC-A](#).

Start/End transmission: The start and end characters of Code 39 are "*"s. You can transmit all data digits including two "*"s.

**** as data character:** By setting Enable, "*" can be recognized as data character.

Convert Code 39 to Code 32: Code 32 is a variant of Code 39 used by the Italian pharmaceutical industry. Note that Code 39 must be enabled in order for this parameter to function.

Format of Code 32

"A" (optional)	Data digits (8 digits)	Check digit
----------------	------------------------	-------------

Code 32 Prefix "A" transmission: By setting Enable, the prefix character "A" can be added to all Code 32 barcodes.













Trioptic Code 39 read: Trioptic Code 39 is a variant of Code 39 used in the marking of magnetic tapes and computer cartridges. Trioptic Code 39 symbols always contain six characters.

Format

Start character (\$)	Data digits (6 digits)	End character (\$)
----------------------	------------------------	--------------------

Trioptic Code 39 Start/End transmission: The start and end characters of Trioptic Code 39 are "\$"s. You can transmit all data digits including two "\$"s.

Multiple-scan setting			Single-scan setting
Option barcode	Option	Alpha.entry	
Read  %1501M%	Disable	00	 %1501D00%
	Enable	01*	 %1501D01% *
Check digit verification  %1502M%	Disable	00*	 %1502D00% *
	Enable	01	 %1502D01%
Check digit transmission  %1503M%	Disable	00*	 %1503D00% *
	Enable	01	 %1503D01%
Max. code length  %1504M%	00-99	00-99	
		00*	 %1504D00% *
Min. code length  %1505M%	00-99	00-99	
		01*	 %1505D01% *
Code ID setting  %1506M%	00-FF ₁₆ (ASCII)	00-FF ₁₆	
		<M>*	 %1506H4D% *
Insert group selection  %1507M%	00-66	00-66	
		00*	 %1507D00% *
Format  %1508M%	Standard	00*	 %1508D00% *
	Full ASCII	01	 %1508D01%
Start/End transmission  %1509M%	Disable	00*	 %1509D00% *
	Enable	01	 %1509D01%
"*" as data character  %1510M%	Disable	00*	 %1510D00% *
	Enable	01	 %1510D01%
Convert Code 39 to	Disable	00*	 %1511D00% *

Multiple-scan setting			Single-scan setting
Option barcode	Option	Alpha.entry	
Code 32  %1511M%	Enable	01	 %1511D01%
Code 32 Prefix "A" transmission  %1512M%	Disable	00*	 %1512D00% *
	Enable	01	 %1512D01%
Trioptic Code 39 read  %1513M%	Disable	00*	 %1513D00% *
	Enable	01	 %1513D01%
Trioptic Code 39 Start/End transmission  %1514M%	Disable	00*	 %1514D00% *
	Enable	01	 %1514D01%
 %END%			

4-13 Interleaved 2 of 5

Read:

Format

Data digits (Variable)	Check digit (optional)
------------------------	------------------------

Check digit verification: The check digit is made as the sum module 10 of the numerical values of all data digits. There are two optional check digit algorithms: the specified Uniform Symbol Specification (USS) and the Optical Product Code Council (OPCC).

Check digit transmission: By setting Enable, check digit will be transmitted.

Max./Min. code length: Refer to

Max./Min. code length

 of *7-10 Code 39*.

Code ID setting: Refer to



















Code ID setting

 of *7-5 UPC-A*.

Insertion group selection: Refer to

Insertion group selection

 of *7-5 UPC-A*.

Multiple-scan setting			Single-scan setting
Option barcode	Option	Alpha. entry	
Read  %1601M%	Disable	00	 %1601D00%
	Enable	01*	 %1601D01% *
Check digit verification  %1602M%	Disable	00*	 %1602D00% *
	USS	01	 %1602D01%
	OPCC	02	 %1602D02%
Check digit transmission  %1603M%	Disable	00*	 %1603D00% *
	Enable	01	 %1603D01%
Max. code length  %1604M%	00-99	00-99	
		00*	 %1604D00% *
Min. code length  %1605M%	00-99	00-99	
		06*	 %1605D06% *
Code ID setting  %1606M%	00-FF ₁₆ (ASCII)	00-FF ₁₆	
		< >*	 %1606H49% *
Insert group selection  %1607M%	00-66	00-66	
		00*	 %1607D00% *



4-14 Industrial 2 of 5 (Discrete 2 of 5)

Read:

Format

Data digits (variable)

Max./Min. code length: Refer to Max./Min. code length of [7-10 Code 39](#).

Code ID setting: Refer to Code ID setting of [7-5 UPC-A](#).

Insertion group selection: Refer to Insertion group selection of [7-5 UPC-A](#).

Multiple-scan setting			Single-scan setting
Option barcode	Option	Alpha. entry	
Read  %1701M%	Disable	00*	 %1701D00% *
	Enable	01	 %1701D01%
Max. code length  %1702M%	00-99	00-99	
		00*	 %1702D00% *
Min. code length  %1703M%	00-99	00-99	
		00*	 %1703D00% *
Code ID setting  %1704M%	00-FF ₁₆ (ASCII)	00-FF ₁₆	
		<H>*	 %1704H48% *
Insert group selection  %1705M%	00-66	00-66	
		00*	 %1705D00% *
 %END%			

4-15 Matrix 2 of 5

Read:

Format

Data digits (variable)	Check digit (optional)
------------------------	------------------------

Check digit verification: The check digit is made as the sum module 10 of the numerical values of all data digits.

Check digit transmission: By setting Enable, check digit will be transmitted.

Max./Min. code length: Refer to

Max./Min. code length

 of [7-10 Code 39](#).

Code ID setting: Refer to













Code ID setting

 of [7-5 UPC-A](#).

Insertion group selection: Refer to

Insertion group selection

 of [7-5 UPC-A](#).

Multiple-scan setting			Single-scan setting
Option barcode	Option	Alpha. entry	
Read  %1801M%	Disable	00	 %1801D00%
	Enable	01*	
Check digit verification  %1802M%	Disable	00*	 %1802D00% *
	Enable	01	 %1802D01%
Check digit transmission  %1803M%	Disable	00*	 %1803D00% *
	Enable	01	 %1803D01%
Max. code length  %1804M%	00-99	00-99	
		00*	
Min. code length  %1805M%	00-99	00-99	
		06*	
Code ID setting  %1806M%	00-FF ₁₆ (ASCII)	00-FF ₁₆	
		<X>*	
Insert group selection  %1807M%	00-66	00-66	
		00*	



4-16 Codabar

Read:

Format

Start character	Data digits (variable)	Check digit (optional)	End character
-----------------	------------------------	------------------------	---------------

Check digit verification: The check digit is made as the sum module 16 of the numerical values of all data digits.

Check digit transmission: By setting Enable, check digit will be transmitted.

Max./Min. code length: Refer to Max./Min. code length of [7-10 Code 39](#).















Code ID setting: Refer to Code ID setting of [7-5 UPC-A](#).















Insertion group selection: Refer to Insertion group selection of [7-5 UPC-A](#).

Start/End type: Codabar has four pairs of Start/End pattern; you may select one pair to match your application.

Start/End transmission: Refer to Start/End transmission of [7-10 Code 39](#).

Start/End character equality: By setting Enable, the start and end character of a Codabar barcode must be the same.

Multiple-scan setting			Single-scan setting
Option barcode	Option	Alpha. entry	
Read  %1901M%	Disable	00	 %1901D00%
	Enable	01*	 %1901D01% *
Check digit verification  %1902M%	Disable	00*	 %1902D00% *
	Enable	01	 %1902D01%
Check digit transmission  %1903M%	Disable	00*	 %1903D00% *
	Enable	01	 %1903D01%
Max. code length  %1904M%	00-99	00-99	
		00*	 %1904D00% *
Min. code length  %1905M%	00-99	00-99	
		00*	 %1905D00% *
Code ID setting  %1906M%	00-FF ₁₆ (ASCII)	00-FF ₁₆	
		<N>*	 %1906H4E% *

Multiple-scan setting			Single-scan setting
Option barcode	Option	Alpha. entry	
Insert group selection  %1907M%	00-66	00-66	
		00*	 %1907D00% *
Start/End type  %1908M%	ABCD/ABCD	00*	 %1908D00% *
	abcd/abcd	01	 %1908D01%
	ABCD/TN*E	02	 %1908D02%
	abcd/tn*e	03	 %1908D03%
Start/End transmission  %1909M%	Disable	00*	 %1909D00% *
	Enable	01	 %1909D01%
Start/End character equality  %1910M%	Disable	00*	 %1910D00% *
	Enable	01	 %1910D01%
 %END%			

4-17 Code 128

Read:

Format

Data digits (variable)	Check digit (optional)
------------------------	------------------------

Check digit verification: The check digit is made as the sum module 103 of all data digits.

Check digit transmission: By setting Enable, check digit will be transmitted.

Max./Min. code length: Refer to

Max./Min. code length

 of [7-10 Code 39](#).

Code ID setting: Refer to

Code ID setting

 of [7-5 UPC-A](#).

Insertion group selection: Refer to

Insertion group selection

 of [7-5 UPC-A](#).

Truncate leading zeros: The leading "0" digits of Code 128 barcode characters can be truncated when the feature is enabled.

Multiple-scan setting			Single-scan setting
Option barcode	Option	Alpha. entry	
Read  %2001M%	Disable	00	 %2001D00%
	Enable	01*	 %2001D01% *
Check digit verification  %2002M%	Disable	00	 %2002D00%
	Enable	01*	 %2002D01% *
Check digit transmission  %2003M%	Disable	00*	 %2003D00% *
	Reserved	01	 %2003D01%
Max. code length  %2004M%	00-99	00-99	
		00*	 %2004D00% *
Min. code length  %2005M%	00-99	00-99	
		01*	 %2005D01% *
Code ID setting  %2006M%	00-FF ₁₆ (ASCII)	00-FF ₁₆	
		<K>*	 %2006H4B% *
Insert group selection  %2007M%	00-66	00-66	
		00*	 %2007D00% *
Truncate leading zeros  %2008M%	Disable	00*	 %2008D00% *
	All leading "0"s	01	 %2008D01%
	Only the first "0"	02	 %2008D02%



4-18 UCC/EAN 128

Read:

Format

Data digits (variable)	Check digit (optional)
------------------------	------------------------

Check digit verification: The check digit is made as the sum module 103 of all data digits.

Check digit transmission: By setting Enable, check digit will be transmitted.

Max. /Min. code length: Refer to

Max./Min. code length

 of *7-10 Code 39*.

Code ID setting: Refer to

Code ID setting

 of *7-5 UPC-A*.

Insertion group selection: Refer to

Insertion group selection

 of *7-5 UPC-A*.

Truncate leading zeros: Refer to

Truncate leading zeros

 of *7-15 Code 128*.

Multiple-scan setting			Single-scan setting
Option barcode	Option	Alpha. entry	
Read  %2501M%	Disable	00	 %2501D00%
	Enable	01*	 %2501D01% *
Check digit verification  %2502M%	Disable	00	 %2502D00%
	Enable	01*	 %2502D01% *
Check digit transmission  %2503M%	Disable	00*	 %2503D00% *
	Reserved	01	 %2503D01%
Max. code length  %2504M%	00-99	00-99	
		00*	 %2504D00% *
Min. code length  %2505M%	00-99	00-99	
		01*	 %2505D01% *
Code ID setting  %2506M%	00-FF ₁₆ (ASCII)	00-FF ₁₆	
		<K>*	 %2506H4B% *
Insert group selection  %2507M%	00-66	00-66	
		00*	 %2507D00% *
Truncate leading zeros  %2508M%	Disable	00*	 %2508D00% *
	All leading "0"s	01	 %2508D01%
	Only the first "0"	02	 %2508D02%



4-19 ISBT 128

Read:

Format

Start character (“=” or “&”)	Data digits (variable)	Check digit (optional)
------------------------------	------------------------	------------------------

Check digit verification: The check digit is made as the sum module 103 of all data digits.

Check digit transmission: By setting Enable, check digit will be transmitted.

Max./Min. code length: Refer to

Max./Min. code length

 of [7-10 Code 39](#).

Code ID setting: Refer to











Code ID setting

 of [7-5 UPC-A](#).

Insertion group selection: Refer to

Insertion group selection

 of [7-5 UPC-A](#).

Multiple-scan setting			Single-scan setting
Option barcode	Option	Alpha. entry	
Read  %3301M%	Disable	00	 %3301D00%
	Enable	01*	 %3301D01% *
Check digit verification  %3302M%	Disable	00	 %3302D00%
	Enable	01*	 %3302D01% *
Check digit transmission  %3303M%	Disable	00*	 %3303D00% *
	Reserved	01	 %3303D01%
Max. code length  %3304M%	00-99	00-99	
		00*	 %3304D00% *
Min. code length  %3305M%	00-99	00-99	
		01*	 %3305D01% *
Code ID setting  %3306M%	00-FF ₁₆ (ASCII)	00-FF ₁₆	
		<K>*	 %3306H4B% *
Insert group selection  %3307M%	00-66	00-66	
		00*	 %3307D00% *
 %END%			

4-20 Code 93

Read:

Format

Data digits (variable)	2 check digits (optional)
------------------------	---------------------------

Check digit verification: The check digit is made as the sum module 47 of the numerical values of all data digits.

Check digit transmission: By setting Enable, check digit will be transmitted.

Max./Min. code length: Refer to

Max./Min. code length

 of [7-10 Code 39](#).

Code ID setting: Refer to

Code ID setting

 of [7-5 UPC-A](#).

Insertion group selection: Refer to

Insertion group selection

 of [7-5 UPC-A](#).

Multiple-scan setting			Single-scan setting
Option barcode	Option	Alpha. entry	
Read  %2101M%	Disable	00	 %2101D00%
	Enable	01*	
Check digit verification  %2102M%	Disable	00	 %2102D00%
	Enable	01*	
Check digit transmission  %2103M%	Disable	00*	 %2103D00% *
	Enable	01	
Max. code length  %2104M%	00-99	00-99	 %2104D00% *
		00*	
Min. code length  %2105M%	00-99	00-99	 %2105D01% *
		01*	
Code ID setting  %2106M%	00-FF ₁₆ (ASCII)	00-FF ₁₆	 %2106H4C% *
		<L>*	
Insert group selection  %2107M%	00-66	00-66	 %2107D00% *
		00*	



4-21 Code 11

Read:

Format

Data digits (variable)	Check digit 1 (optional)	Check digit 2 (optional)
------------------------	---------------------------	--------------------------

Check digit verification: The check digit is presented as the sum module 11 of all data digits.

Check digit transmission: By setting Enable, check digit 1 and check digit 2 will be transmitted upon your selected check digit verification method.

Max./Min. code length: Refer to

Max./Min. code length

 of *7-10 Code 39*.

Code ID setting: Refer to

Code ID setting

 of *7-5 UPC-A*.

Insertion group selection: Refer to

Insertion group selection

 of *7-5 UPC-A*.

Multiple-scan setting			Single-scan setting
Option barcode	Option	Alpha. entry	
Read  %2201M%	Disable	00*	 %2201D00% *
	Enable	01	 %2201D01%
Check digit verification  %2202M%	Disable	00	 %2202D00%
	One digit	01*	 %2202D01% *
	Reserved	02	 %2202D02%
	Reserved	03	 %2202D03%
Check digit transmission  %2203M%	Disable	00*	 %2203D00% *
	Enable	01	 %2203D01%
Max. code length  %2204M%	00-99	00-99	
		00*	 %2204D00% *
Min. code length  %2205M%	00-99	00-99	
		00*	 %2205D00% *
Code ID setting  %2206M%	00-FF ₁₆ (ASCII)	00-FF ₁₆	
		<V>*	 %2206H56% *
Insert group selection  %2207M%	00-66	00-66	
		00*	 %2207D00% *
 %END%			

4-22 MSI/Plessey

Read:

Format

Data digits (variable)	Check digit 1 (optional)	Check digit 2 (optional)
------------------------	--------------------------	--------------------------

Check digit verification: The MSI/Plessey has one or two optional check digits. There are three methods of verifying check digits, i.e. Mod 10, Mod 10/10 and Mod 10/11. The check digit 1 and check digit 2 will be calculated as the sum module 10 or 11 of the data digits.

Check digit transmission: By setting Enable, check digit 1 and check digit 2 will be transmitted upon your selected check digit verification method.

Max./Min. code length: Refer to

Max./Min. code length

 of [7-10 Code 39](#).

Code ID setting: Refer to

Code ID setting

 of [7-5 UPC-A](#).

Insertion group selection: Refer to

Insertion group selection

 of [7-5 UPC-A](#).

Multiple-scan setting			Single-scan setting
Option barcode	Option	Alpha. entry	
Read  %2301M%	Disable	00*	 %2301D00% *
	Enable	01	 %2301D01%
Check digit verification  %2302M%	Disable	00*	 %2302D00% *
	1 digit (Mod 10)	01	 %2302D01%
	2 digits (Mod 10/10)	02	 %2302D02%
	2 digits (Mod 10/11)	03	 %2302D03%
Check digit transmission  %2303M%	Disable	00*	 %2303D00% *
	Enable	01	 %2303D01%
Max. code length  %2304M%	00-99	00-99	
		00*	 %2304D00% *
Min. code length  %2305M%	00-99	00-99	
		00*	 %2305D00% *
Code ID setting  %2306M%	00-FF ₁₆ (ASCII)	00-FF ₁₆	
		<O>*	 %2306H4F% *
Insert group selection  %2307M%	00-66	00-66	
		00*	 %2307D00% *



4-23 UK/Plessey

Read:

Format

Data digits (variable)	2 check digits (optional)
------------------------	---------------------------

Check digit verification: The UK/Plessey has one or two optional check digits. The check digit 1 and check digit 2 will be calculated as the sum module 10 or 11 of the data digits.

Check digit transmission: By setting Enable, check digit will be transmitted.

Max./Min. code length: Refer to

Max./Min. code length

 of [7-10 Code 39](#).

Code ID setting: Refer to



















Code ID setting

 of [7-5 UPC-A](#).

Insertion group selection: Refer to

Insertion group selection

 of [7-5 UPC-A](#).

Multiple-scan setting			Single-scan setting
Option barcode	Option	Alpha. entry	
Read  %2401M%	Disable	00*	 %2401D00% *
	Enable	01	 %2401D01%
Check digit verification  %2402M%	Disable	00	 %2402D00%
	Enable	01*	 %2402D01% *
Check digit transmission  %2403M%	Disable	00*	 %2403D00% *
	Enable	01	 %2403D01%
Max. code length  %2404M%	00-99	00-99	
		00*	 %2404D00% *
Min. code length  %2405M%	00-99	00-99	
		01*	 %2405D01% *
Code ID setting  %2406M%	00-FF ₁₆ (ASCII)	00-FF ₁₆	
		<U>*	 %2406H55% *
Insert group selection  %2407M%	00-66	00-66	
		00*	 %2407D00% *
 %END%			

4-24 China Post

Read:

Format

11 Data digits

Max. /Min. code length: Refer to **Max./Min. code length** of [7-10 Code 39](#). The code length of China Post is 11.

Code ID setting: Refer to **Code ID setting** of [7-5 UPC-A](#).

Insertion group selection: Refer to **Insertion group selection** of [7-5 UPC-A](#).

Multiple-scan setting			Single-scan setting
Option barcode	Option	Alpha. entry	
Read  %2601M%	Disable	00	 %2601D00%
	Enable	01*	 %2601D01% *
Max. code length  %2604M%	00-99	00-99	
		11*	 %2604D11% *
Min. code length  %2605M%	00-99	00-99	
		11*	 %2605D11% *
Code ID setting  %2606M%	00-FF ₁₆ (ASCII)	00-FF ₁₆	
		<T>*	 %2606H54% *
Insert group selection  %2607M%	00-66	00-66	
		00*	 %2607D00% *
 %END%			

4-25 China Finance

Note: This type of barcode is not Omni-directionally decodable. The encodable character set includes numeric 0 to 9. Among the symbol of 0 to 9, 0 and 2, 4 and 9, 5 and 8, 6 and 7, have the symmetrical pattern; the pattern of 1 and 3 is symmetrical.

Read:

Format

10 Data digits

Max./Min. code length: Refer to Max./Min. code length of [7-10 Code 39](#).











Check digit verification: The check digit is made as the sum module 10 of the numerical values of all data digits.





















Leading character 5/6/7/8/9 converted to A/B/C/D/E: By setting, leading character 5/6/7/8/9 can be converted to A/B/C/D/E.

Leading character assignment: By setting, only the barcode with the assigned leading character can be output.

Code ID setting: Refer to Code ID setting of [7-5 UPC-A](#).

Insertion group selection: Refer to Insertion group selection of [7-5 UPC-A](#).

Multiple-scan setting			Single-scan setting
Option barcode	Option	Alpha. entry	
Read  %3201M%	Disable	00	 %3201D00%
	Enable	01*	 %3201D01% *
Max. code length  %3202M%	00-99	00-99	
		10*	 %3202D10% *
Min. code length  %3203M%	00-99	00-99	
		10*	 %3203D10% *
Check digit verification  %3204M%	Disable	00*	 %3204D00% *
	Reserved	01	 %3204D01%
Leading character 5/6/7/8/9 converted to A/B/C/D/E  %3205M%	Disable	00	 %3205D00%
	Enable	01*	 %3205D01% *
	Only 5 converted to A	02	 %3205D02%
	Only 6 converted to B	03	 %3205D03%

Multiple-scan setting			Single-scan setting
Option barcode	Option	Alpha. entry	
	Only 7 converted to C	04	 %3205D04%
	Only 8 converted to D	05	 %3205D05%
	Only 9 converted to E	06	 %3205D06%
Leading character assignment  %3206M%	Disable	00	 %3206D00%
	Assigned to 0	01*	 %3206D01% *
	Assigned to 5(A)	02	 %3206D02%
	Assigned to 6(B)	03	 %3206D03%
	Assigned to 7(C)	04	 %3206D04%
	Assigned to 8(D)	05	 %3206D05%
	Assigned to 9(E)	06	 %3206D06%
	Assigned to 1	07	 %3206D07%
	Assigned to 2	08	 %3206D08%
	Assigned to 3	09	 %3206D09%
	Assigned to 4	10	 %3206D10%
Code ID setting  %3207M%	00-FF ₁₆ (ASCII)	00-FF ₁₆	
		<Y>*	 %3207H59% *
Insert group selection  %3208M%	00-66	00-66	
		00*	 %3208D00% *
 %END%			

4-26 GS1 DataBar (GS1 DataBar Truncated)

GS1 DataBar Truncated is structured and encoded the same as the standard GS1 DataBar format, except its height is reduced to a 13 modules minimum; while GS1 DataBar should have a height greater than or equal to 33 modules.

Read:

Format

16 Data digits











Code ID setting: Refer to Code ID setting of [7-5 UPC-A](#).

Insertion group selection: Refer to Insertion group selection of [7-5 UPC-A](#).

Conversion:

UCC/EAN 128- Refer to Code ID transmission of [7-35 String transmission](#),]Cm will be identified as AIM ID.

UPC-A or EAN-13- Barcode beginning with a single zero as the first digit has the leading “010” stripped and the barcode reported as EAN-13. Barcode beginning with two or more zeros but not six zeros has the leading “0100” stripped and the barcode reported as UPC-A.

Multiple-scan setting			Single-scan setting
Option barcode	Option	Alpha. entry	
Read  %2701M%	Disable	00	 %2701D00%
	Enable	01*	 %2701D01% *
Code ID setting  %2702M%	00-FF ₁₆ (ASCII)	00-FF ₁₆	
		<R>*	 %2702H52% *
Insert group selection  %2703M%	00-66	00-66	
		00*	 %2703D00% *
Conversion  %2704M%	None	00*	 %2704D00% *
	UCC/EAN 128	01	 %2704D01%
	UPC-A or EAN-13	02	 %2704D02%



4-27 GS1 DataBar Limited

Read:







Format

16 Data digits

Code ID setting: Refer to [Code ID setting](#) of [7-5 UPC-A](#).

Insertion group selection: Refer to [Insertion group selection](#) of [7-5 UPC-A](#).

Conversion: Refer to [Conversion](#) of [7-24 GS1 DataBar \(GS1 DataBar Truncated\)](#).

Multiple-scan setting			Single-scan setting
Option barcode	Option	Alpha. entry	
Read  %2801M%	Disable	00	 %2801D00%
	Enable	01*	 %2801D01% *
Code ID setting  %2802M%	00-FF ₁₆ (ASCII)	00-FF ₁₆	
		<R>*	 %2802H52% *
Insert group selection  %2803M%	00-66	00-66	
		00*	 %2803D00% *
Conversion  %2804M%	None	00*	 %2804D00% *
	UCC/EAN 128	01	 %2804D01%
	UPC-A or EAN-13	02	 %2804D02%
 %END%			

4-28 GS1 DataBar Expanded

Read:

Format

Data characters (variable)

Code ID setting: Refer to Code ID setting of [7-5 UPC-A](#).

Insertion group selection: Refer to Insertion group selection of [7-5 UPC-A](#).

Conversion:

UCC/EAN 128- Refer to Code ID transmission of [7-35 String transmission](#),]Cm will be identified as AIM ID.





Multiple-scan setting			Single-scan setting
Option barcode	Option	Alpha. entry	
Read  %2901M%	Disable	00	 %2901D00%
	Enable	01*	 %2901D01% *
Max. code length  %2902M%	00-99	00-99	
		00*	 %2902D00% *
Min. code length  %2903M%	00-99	00-99	
		01*	 %2903D01% *
Code ID setting  %2904M%	00-FF ₁₆ (ASCII)	00-FF ₁₆	
		<R>*	 %2904H52% *
Insert group selection  %2905M%	00-66	00-66	
		00*	 %2905D00% *
Conversion  %2906M%	None	00*	 %2906D00% *
	UCC/EAN 128	01	 %2906D01%
 %END%			

4-29 PDF417

Read:

Format

Data characters (variable)





Multiple-scan setting			Single-scan setting
Option barcode	Option	Alpha. entry	
Read  %3001M%	Disable	00	 %3001D00%
	Enable	01*	 %3001D01% *
 %END%			

4-30 MicroPDF417

Read:

Format

Data characters (variable)





Multiple-scan setting			Single-scan setting
Option barcode	Option	Alpha. entry	
Read  %3101M%	Disable	00	 %3101D00%
	Enable	01*	 %3101D01% *
 %END%			

4-31 QR Code

Read:

Format

Data characters (variable)







Multiple-scan setting			Single-scan setting
Option barcode	Option	Alpha. entry	
Read  %4001M%	Disable	00	 %4001D00%
 %4001M%	Enable	01*	 %4001D01% *
 %END%			

4-32 Micro QR Code

Read:

Format

Data characters (variable)





Multiple-scan setting				Single-scan setting
Option barcode	Parameters of the code	Option	Alpha. entry	
Read  %4501M%	0x11 0x95	Disable	00*	 %4501D00% *
		Enable	01	 %4501D01%
Code ID setting  %4502M%	0x11 0x96	00-FF ₁₆ (ASCII)	00-FF ₁₆	
			<q>*	 %4502H71% *
 %END%				

4-33 Data Matrix

Read:

Format

Data characters (variable)





Multiple-scan setting			Single-scan setting
Option barcode	Option	Alpha. entry	
Read  %4101M%	Disable	00	 %4101D00%
	Enable	01*	 %4101D01% *
 %END%			

4-34 Aztec Code

Read:

Format

Data characters (variable)

Multiple-scan setting			Single-scan setting
Option barcode	Option	Alpha. entry	
Read  %4301M%	Disable	00	 %4301D00%
	Enable	01*	 %4301D01% *
 %END%			

4-35 G1-G6 & C1-C3 & FN1 substitution string setting

Format of barcode data transmission:

Prefix	Code name	Preamble	Code ID	Code length	Code data	Code ID	Postamble	Suffix
--------	-----------	----------	---------	-------------	-----------	---------	-----------	--------

Suffix string setting: The <enter> key is represented in different ASCII when it is applied by different OS. For a Windows/DOS OS, <enter> is represented as <CR><LF> (0x0D 0x0A); for an Apple MAC OS, <enter> is represented as <CR> (0x0D); for a Linux/Unix OS, <enter> is represented as <LF> (0x0A).

Prefix/Suffix/Preamble/Postamble string setting:

They are appended to the data automatically when a barcode is decoded.

Example: Add a symbol of “\$” as a prefix for all symbols.

Steps:

- 1) Scan the option barcode of Prefix string setting.
- 2) Use the ASCII table to find the value of \$→24.
- 3) Scan 2 and 4 from the barcode on the last page.
- 4) Scan END barcode.

Scanning steps: Scan the following barcodes in order.

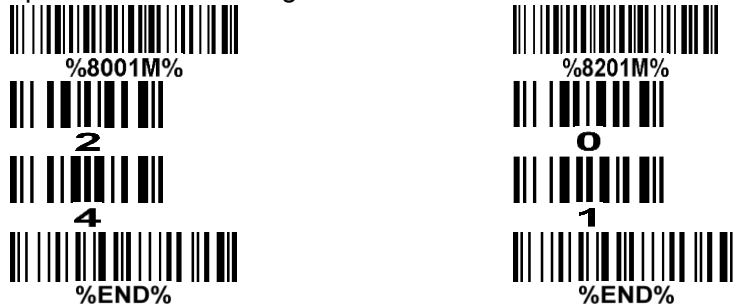

Insert G1/G2/G3/G4 string setting: The scanner offers 4 positions and 4 character strings to insert among the symbol.

Example: Set G1 string to be “AB”.

Original code data	“1 2 3 4 5 6”
Output code data	“1 2 A B 3 4 5 6”

Steps:

- 1) Scan the option barcode of Insert G1 string setting.
- 2) Use the ASCII table to find the value of A→41, B→42.
- 3) Scan 4, 1 and 4, 2 from the barcode on the last page.
- 4) Scan END barcode.
- 5) Refer to [7-34 G1-G4 string position & Code ID position](#).
- 6) Refer to [7-4 Scanning mode and some global settings](#).



Testing barcode:



FN1 substitution string setting: The FN1 character (0x1D) in an UCC/EAN128 barcode, or a Code 128 barcode, or a GS1 DataBar barcode can be substituted with a defined string.

Single character C1/C2 replacement: By setting, a defined character in the data string can be replaced by another defined character. The C1 and C2 replacement can be applied simultaneously.

Example: Replace all the “A” character in a data string with “B” character.

Original code data	“1 2 3 A 5 A”
Output code data	“1 2 3 B 5 B”

Steps: scan the following barcodes in order. The ASCII value for “A” is 41, and the ASCII value for “B” is 42.



%8014M%



4



1



4



2





%END%

Testing barcode:



123A5A

Multiple-scan setting			Single-scan setting
Option barcode	Option	Alpha. Entry	
Prefix string setting  %8001M%	0-22 characters	00-FF ₁₆	
	None	00*	 %8001H00% *
Suffix string setting  %8002M%	0-22 characters	00-FF ₁₆	
	<ENTER>	0D0A*	
Preamble string setting  %8003M%	0-22 characters	00-FF ₁₆	
	None	00*	 %8003H00% *
Postamble string setting  %8004M%	0-22 characters	00-FF ₁₆	
	None	00*	 %8004H00% *
Insert G1 string setting  %8005M%	0-22 characters	00-FF ₁₆	
	None	00*	 %8005H00% *
Insert G2 string setting  %8006M%	0-22 characters	00-FF ₁₆	
	None	00*	 %8006H00% *
Insert G3 string setting  %8007M%	0-22 characters	00-FF ₁₆	
	None	00*	 %8007H00% *
Insert G4 string setting  %8008M%	0-22 characters	00-FF ₁₆	
	None	00*	 %8008H00% *
FN1 substitution string setting  %8009M%	0-4 characters	00-FF ₁₆	
	<SP>	20*	 %8009H20% *
Single character C1 replacement  %8014M%	<0000>	0000*	
		0000-FFFF ₁₆	
Single character C2	<0000>	0000*	

Multiple-scan setting			Single-scan setting
Option barcode	Option	Alpha. Entry	
replacement  %8015M%		0000-FFFF ₁₆	
 %END%			







4-36 G1-G4 string position & Code ID position

Format of barcode data transmission:

Prefix	Code name	Preamble	Code ID	Code length	Code data	Code ID	Postamble	Suffix
--------	-----------	----------	---------	-------------	-----------	---------	-----------	--------

Insert G1/G2/G3/G4 string position: The scanner offers 4 positions to insert strings among the symbol. In case of the insertion position is greater than the length of the symbol, the insertion of string is not effective.

Code ID position: It is allowed to select different positions of code ID placement.

Multiple-scan setting			Single-scan setting
Option barcode	Option	Alpha. entry	
Insert G1 string position  %8101M%	00-99	00-99	 %8101D00% *
		00*	
Insert G2 string position  %8102M%	00-99	00-99	 %8102D00% *
		00*	
Insert G3 string position  %8103M%	00-99	00-99	 %8103D00% *
		00*	
Insert G4 string position  %8104M%	00-99	00-99	 %8104D00% *
		00*	
Code ID position  %8105M%	Before code data	00*	 %8105D00% *
	After code data	01	 %8105D01%
 %END%			

4-37 String transmission

Note: The information in this chapter is closely related to 7-33 G1-G6 & C1-C3 & FN1 substitution string setting.

Format of barcode data transmission:

Prefix	Code name	Preamble	Code ID	Code length	Code data	Code ID	Postamble	Suffix
--------	-----------	----------	---------	-------------	-----------	---------	-----------	--------

Prefix transmission: By setting Enable, prefix will be appended before the data transmitted.

Suffix transmission: By setting Enable, suffix will be appended after the data is transmitted.

Code name transmission: By setting Enable, code name will be transmitted before code data.

Preamble transmission: By setting Enable, preamble will be appended before the data transmitted.

Postamble transmission: By setting Enable, postamble will be appended after the data is transmitted.

Code ID transmission: Code ID can be transmitted in the format of either Proprietary ID or AIM ID.

Refer to [1-2 Default setting for each barcode.](#)

Code length transmission: The length of code data string can be transmitted before the code data when Enable is selected. The length is represented by a number with two digits.

Case conversion: The characters within code data or the whole output string can be set in either upper case or lower case.

FN1 substitution transmission: The scanner supports a FN1 substitution feature for keyboard wedge, USB and RS-232 interface. The replacement string of FN1 can be chosen by user (see [4-35 G1-G6 & C1-C6 & FN1 substitution string setting](#)).





























All-non-printable-character string transmission with string setting: By setting enable, all string settings, e.g.













Preamble transmission or Insert G1 string setting, are active for an all-non-printable-character string.

Here a non-printable character means a character with ASCII value between 0x00 to 0x1F.

Transmit the first N data characters only: The scanner supports to only transmit the first N data characters of a barcode. The number of N can be set as a digit between 1 and 99.

Transmit the last N data characters only: The scanner supports to only transmit the last N data characters of a barcode. The number of N can be set as a digit between 1 and 99.

Multiple-scan setting			Single-scan setting
Option barcode	Option	Alpha. entry	
Prefix transmission  %8201M%	Disable	00*	 %8201D00% *
	Enable	01	 %8201D01%
Suffix transmission  %8202M%	Disable	00	 %8202D00%
	Enable	01*	 %8202D01% *
Code name transmission  %8203M%	Disable	00*	 %8203D00% *
	Enable	01	 %8203D01%
Preamble transmission  %8204M%	Disable	00*	 %8204D00% *
	Enable	01	 %8204D01%
Postamble transmission  %8205M%	Disable	00*	 %8205D00% *
	Enable	01	 %8205D01%
Code ID transmission  %8206M%	Disable	00*	 %8206D00% *
	Proprietary ID	01	 %8206D01%
	AIM ID	02	 %8206D02%
Code length transmission  %8207M%	Disable	00*	 %8207D00% *
	Enable	01	 %8207D01%
Case conversion  %8208M%	Disable	00*	 %8208D00% *
	Upper (data only)	01	 %8208D01%
	Lower (data only)	02	 %8208D02%
	Upper (whole string)	03	 %8208D03%
	Lower (whole string)	04	 %8208D04%
FN1 substitution	Disable	00*	 %8209D00% *

Multiple-scan setting			Single-scan setting
Option barcode	Option	Alpha. entry	
transmission  %8209M%	Keyboard wedge/USB	01	 %8209D01%
	RS-232	02	 %8209D02%
	Keyboard wedge / USB/RS-232	03	 %8209D03%
All-non-printable-character string transmission with string setting  %8210M%	Disable	00*	 %8210D00% *
	Enable	01	 %8210D01%
Transmit the first N data characters only  %8211M%	All	99*	 %8211D99% *
	01-99		
Transmit the last N data characters only  %8212M%	All	99*	 %8212D99% *
	01-99		
 %END%			

5 Barcode representing non-printable character

Notes to make the following barcode:

1. According to different barcode printing software, the method of printing following barcode is different.
2. If using CODESOFT software, firstly read the information through “Help→Index→Code128→Special input syntax”. Also refer to ASCII table. For example, if we wish to make “F1” barcode, select “Code128”, then select “CODE A” type, and input “{DC1}” as data.



6 ASCII Table

L \ H		for keyboard wedge		for RS-232	
		0	1	0	1
0		Null		NUL	DLE
1		Up	F1	SOH	DC1
2		Down	F2	STX	DC2
3		Left	F3	ETX	DC3
4		Right	F4	EOT	DC4
5		PgUp	F5	ENQ	NAK
6		PgDn	F6	ACK	SYN
7			F7	BEL	ETB
8		Bs	F8	BS	CAN
9		Tab	F9	HT	EM
A			F10	LF	SUB
B		Home	Esc	VT	ESC
C		End	F11	FF	FS
D		Enter	F12	CR	GS
E		Insert	Ctrl+	SO	RS
F		Delete	Alt+	SI	US

Notes: The 2nd and the 3rd columns above are used for keyboard wedge only.

L \ H		2	3	4	5	6	7
0		SP	0	@	P	`	p
1		!	1	A	Q	a	q
2		"	2	B	R	b	r
3		#	3	C	S	c	s
4		\$	4	D	T	d	t
5		%	5	E	U	e	u
6		&	6	F	V	f	v
7		'	7	G	W	g	w
8		(8	H	X	h	x
9)	9	I	Y	i	y
A		*	:	J	Z	j	z
B		+	;	K	[k	{
C		,	<	L	\	l	
D		-	=	M]	m	}
E		.	>	N	^	n	~
F		/	?	O	_	o	DEL

Example: ASCII "A" = "41".

7 Test Chart

UPC-A
6 59871 23231 9

UPC-E
0 232310 7

UPC-E1
(Default setting: Disable)

1 6 5 4 3 2 1 1

EAN-13
1 234567 891019

ISBN/ISSN
9 780194 315104

EAN-8
0 123 4510

Code 39
0189-.\$AZ

Interleaved 2 of 5
0123456789

Industrial 2 of 5
(Default setting: Disable)
0123456789

Matrix 2 of 5
9876543210

Codabar
a01+-:.\$89a

Code 128
01AZ[+~*/]za98

UCC/EAN 128
01AZ[]+-az54

Test Chart (Continued)

ISBT 128



=1234 56789

Code 93



01AZ+/-*az89

Code 11

(Default setting: Disable)



123456789-0

MSI/Plessey

(Default setting: Disable)



0123456789

UK/Plessey



01ABEF89

China Post



54789632145

GS1 DataBar (GS1 DataBar Truncated)



(01) 12345678901231

GS1 DataBar Limited



(01) 1 2345678 90126 2

GS1 DataBar Expanded



Ab_09+yZ

Test Chart (Continued)

PDF417



12=890ab-+%xyz

MicroPDF417

(Default setting: Disable)



12345678abcABCMicroPDF417

QR code



1234567890ABCD-+()&*%^@#\$.XYZ

Micro QR Code

(Default setting: Disable)



0123456789MicroQR

Data Matrix



123890abc-+=&*%^!mdo

Aztec Code

(Default setting: Disable)



12345678901234567890

8 Return default parameters & firmware version



%%%DEF

WARNING: Restore Factory Defaults

Scan this barcode to restore the factory default values.



%%%VER

Engine Firmware Version List

Scan this barcode to display the engine firmware version.



%%SVER

Device Firmware Version List

Scan this barcode to display the device firmware version.



%%BVER

Bluetooth Version List

Scan this barcode to display the device bluetooth version.

9 Configuration alphanumeric entry barcode



0



2



4



6



8



A



C



E



1



3



5



7



9



B



D



F

To finish parameter setting, please scan the bar code below.



%%%END